

# THE PERFECT EMOTION IN BATHROOM

*/ Faucet Collection /*

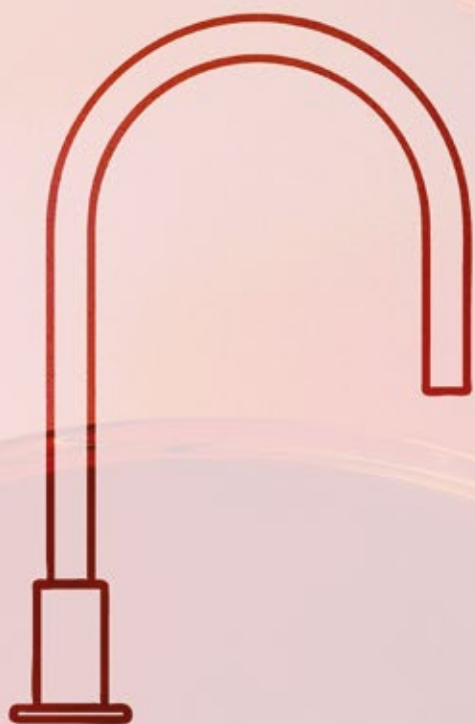

**Kartell** by **LAUFEN**



*/ faucet collection /*

# Kartell + Laufen: emotion in lifestyle



Designers – Ludovica + Roberto Palomba

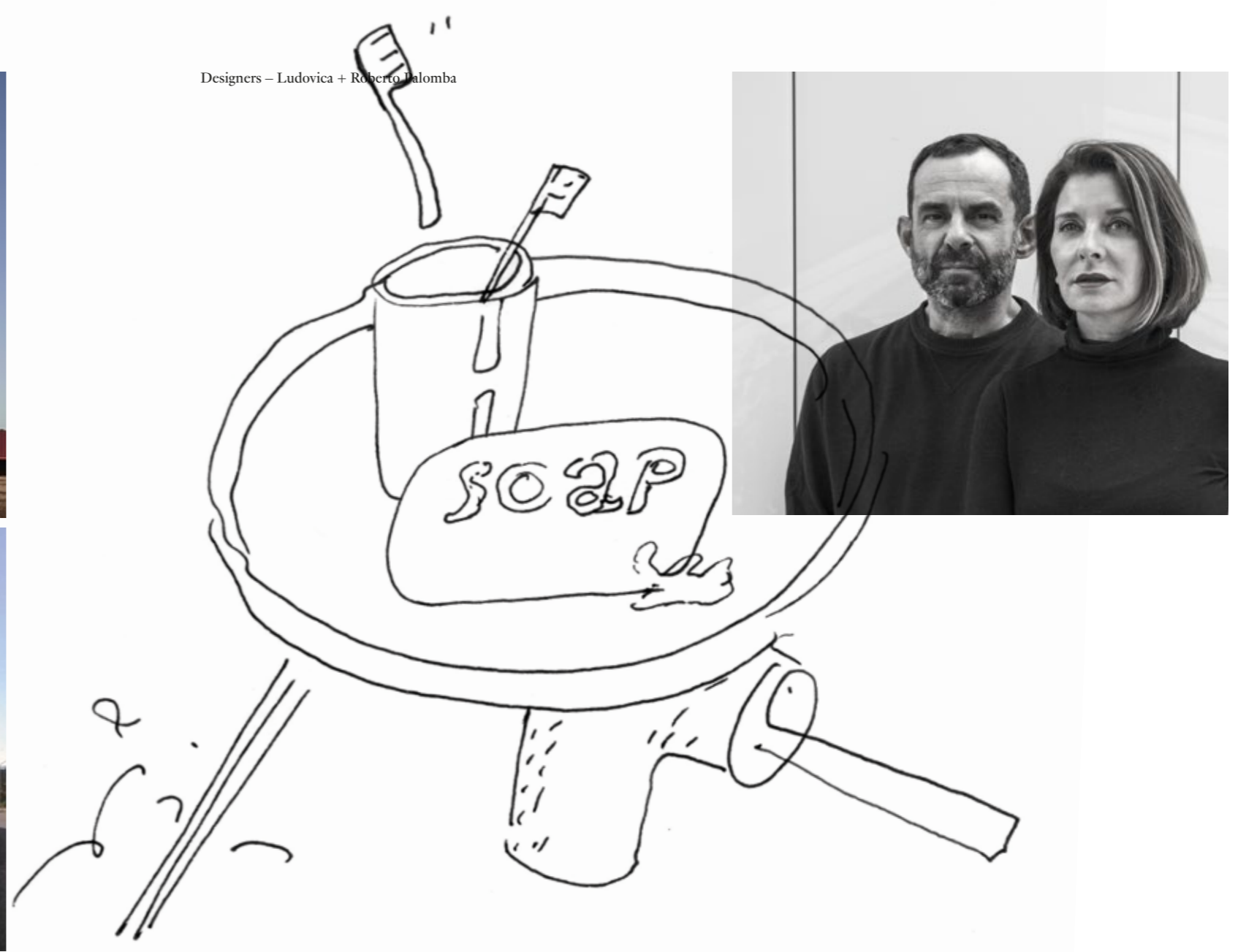

“AN ARCHITECTURAL PROJECT THAT SPEAKS A NEW LANGUAGE. INNOVATIVE, RICH IN EMOTION, TRANSPARENCY AND COLOUR. THE KARTELL BY LAUFEN BATHROOM IS THE SYNTHESIS OF THE WORK WE HAVE DONE IN RECENT YEARS IN THE WORLD OF THE BATHROOM AND REPRESENTS AN IMPORTANT STEP FORWARD IN THIS SECTOR.”

Ludovica+Roberto Palomba have a long time partnership with Laufen.

When the idea to create a new, collaborative collection with Kartell emerged, it was only natural that these two Multi award-winning designers would become art directors of the project.

Ludovica+Roberto are the most recognised bathroom designers of the moment and have earned the merit of having reinvented the concept of the bathroom.

Ludovica+Roberto Palomba were the creative “joint” between the two brands, able to understand and interpret each specific DNA, translating them into a unique and integrated concept in which both companies recognize themselves. A demanding task that could be achieved only by receptive and of caliber designers such they are.

„EIN ARCHITEKTONISCHES PROJEKT, DAS EINE NEUE SPRACHE SPRICHT. INNOVATIV, REICH AN EMOTIONEN, TRANSPARENZ UND FARBE. KARTELL BY LAUFEN IST DIE SYNTHESE DER ARBEIT, DIE WIR IN DEN LETZTEN JAHREN IN DER WELT DES BADEZIMMERS GELEISTET HABEN UND STELLT EINEN WICHTIGEN FORTSCHRITT IN DIESEM BEREICH DAR.“

Ludovica+Roberto Palomba stehen schon seit langer Zeit in enger Beziehung zu Laufen. Laufen ist der führende Schweizer Hersteller von Sanitäreinrichtungen und bekannt für Innovationen im Bereich hochwertiger Keramik. Als die Idee zur Zusammenarbeit von Laufen und Kartell, der renommierten italienischen Designmarke bekannt durch ikonische Plastik Entwürfe, entstand, lag es auf der Hand, dass L+R Palomba als mehrfach ausgezeichnete und erfahrene Designer – unter anderem im Bad, die künstlerische Leitung des Projektes übernehmen.

Sie sind die kreative Verbindung, die zur erfolgreichen Zusammenarbeit und Realisation des Gesamtkonzept für das Badezimmer verhalf. Geleitet durch den fein austarierten gestalterischen Ansatz übersetzten und vereinte das Designer-Paar die zwei DNAs der starken Marken Kartell und Laufen.

“UN PROGETTO ARCHITETTONICO CHE PARLA UN NUOVO LINGUAGGIO. INNOVATIVO, RICCO DI EMOZIONI, TRASPARENZA E COLORE. IL PROGETTO KARTELL BY LAUFEN È LA SINTESI DI TUTTO IL LAVORO SVOLTO NEGLI ULTIMI ANNI NEL MONDO DEL BAGNO E RAPPRESENTA UN ENORME PASSO IN AVANTI PER L'INTERO SETTORE.”

Ludovica e Roberto Palomba collaborano da lungo tempo con Laufen.

Quando nacque l'idea di creare una nuova collezione con Kartell è stato naturale pensare ai due pluripremiati designer come direttori creativi di questo progetto. Ludovica e Roberto Palomba sono oggi i designer più riconosciuti al mondo nella progettazione dell'ambiente bagno e spetta a loro il merito di avere re-inventato il concetto della stanza da bagno.

Rappresentano “il punto di contatto” creativo tra i due brand. Acuti nel comprendere ed interpretare i loro specifici DNA, traducendoli in un progetto unico ed integrato nel quale entrambe le aziende si riconoscono. Un compito impegnativo che poteva essere portato a termine solo da professionisti di calibro. Ludovica+Roberto Palomba sono stati l'anello di congiunzione creativo fra le due aziende.

« UN PROJET D'ARCHITECTURE, QUI S'EXPRIME EN UN LANGAGE NOUVEAU. INNOVANT, RICHE EN ÉMOTION, TRANSPARENCE ET COULEUR. KARTELL BY LAUFEN EST LA SYNTHÈSE DU TRAVAIL QUE NOUS AVONS FAIT EN CES DERNIÈRES ANNÉES DANS LE DOMAINE DE LA SALLE DE BAINS, ET REPRÉSENTE UN AVANCEMENT IMPORTANT DANS CE SECTEUR».

Ludovica et Roberto Palomba collaborent depuis longtemps avec Laufen.

Quand l'idée fût conçue de créer une nouvelle collection avec Kartell, les deux designers de renommée internationale ont été le choix naturel comme directeurs créatifs de ce projet.

Ludovica et Roberto Palomba sont à présent les deux designers les plus reconnus dans le domaine des projets destinés à la salle de bains, et ce sont eux qui ont réinventé le concept même de salle de bains. Ils représentent le « point de contact » créatif entre les deux marques, et sont capables d'en percevoir et interpréter leurs ADN spécifiques en les traduisant en un projet unique et complet, dans lequel les deux entreprises peuvent se reconnaître. Un vrai défi, qui ne pouvait être accepté que par deux grands professionnels comme eux.



Just like a dialogue between opposite poles:  
lightness and weight, play and rigour,  
eclecticism and minimalism.



# Mixer

- \* Special colours available from 100 pcs.
- \* Sonderfarben verfügbar ab 100 Stk.
- \* Couleurs spéciales disponibles à partir de 100 pc.
- \* Colori speciali disponibili da 100 pz.

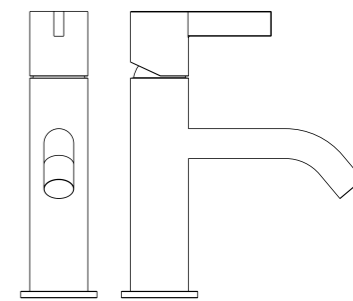

*/ basin mixer /*



*/ basin mixer /*



*/ column basin mixer /*



*/ bidet mixer /*

## Special colours



*/ PVD inox look /  
/ PVD Edelmetall look /  
/ PVD look acier inox /  
/ PVD look inox /*



*/\* PVD gold /  
/\* PVD Gold /  
/\* PVD or /  
/\* PVD oro /*



*/\* PVD brushed anthracite /  
/\* PVD Anthrazit gebürstet /  
/\* PVD anthracite brossé /  
/\* PVD antracite spazzolato /*

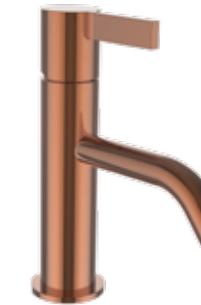

*/\* PVD copper /  
/\* PVD Kupfer /  
/\* PVD cuivre /  
/\* PVD rame /*



Column basin mixer — PVD brushed anthracite



Basin mixer — PVD inox look



Basin mixer — PVD gold



And it is in the texture of the background, always changing,  
that the stage of emotions finally becomes complete.



# Hi-Arc

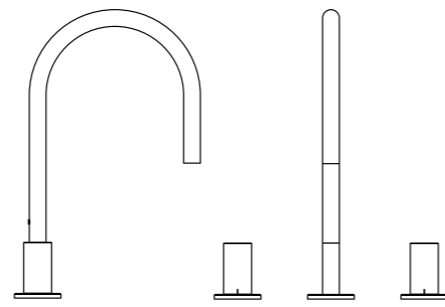

*/ 3-hole basin mixer /*



*/ 2-hole basin mixer /*



*/ roman tub filler 5-boles /*



*/ wall-mounted mixer,  
2-Point /*



*/ basin wall mixer,  
2-handle /*



*/ wall-mounted  
fixed spout 175 mm /*



*/ shower mixer /*



*/ set for concealed shower  
mixer /*



*/ set for concealed bath or  
shower mixer /*





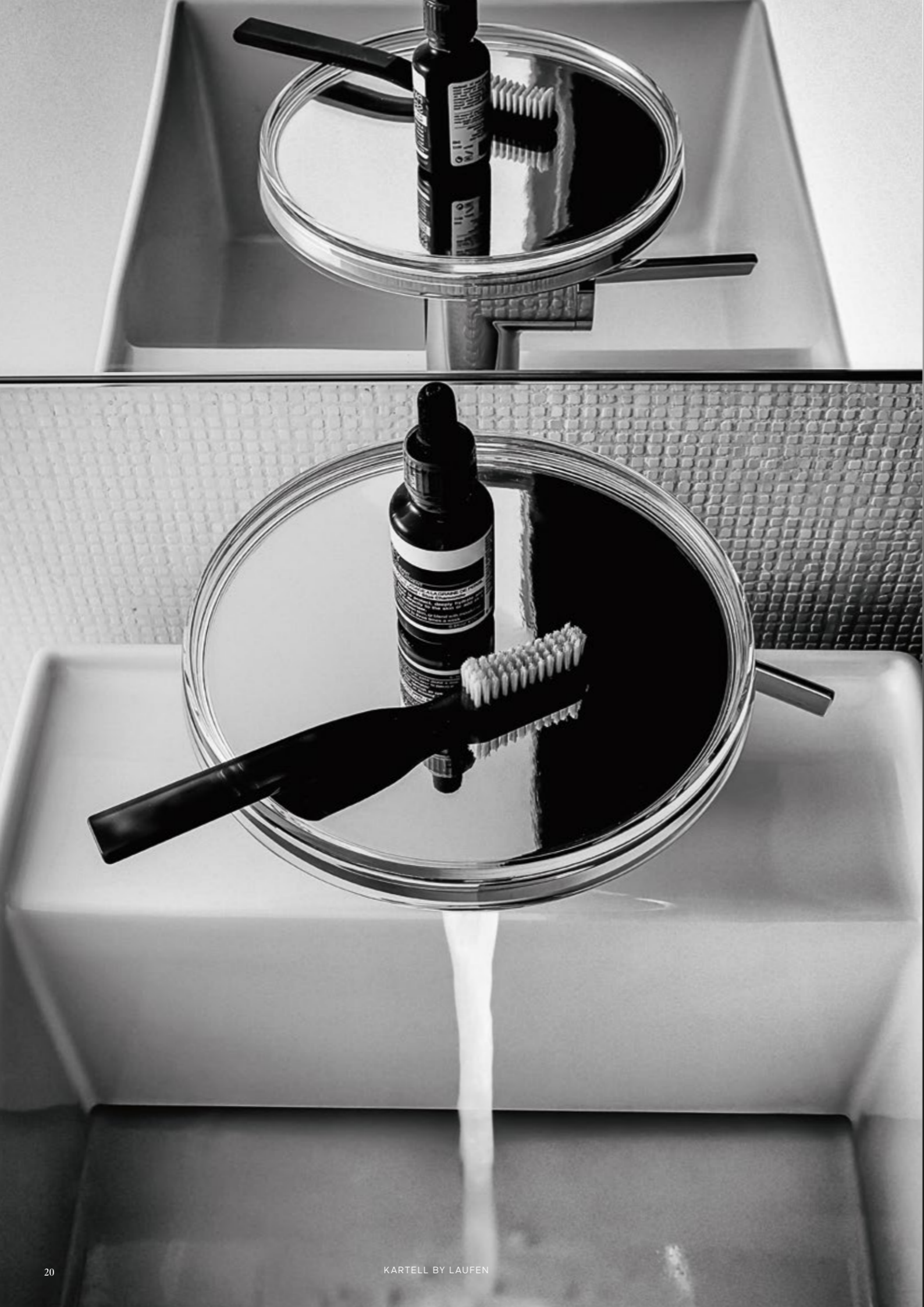

Then there's the monumentality, transparency, and purity of the elements, that take an ideal view of architectural volumes, while projecting these objects onto an exceptionally light horizon.



# Disc

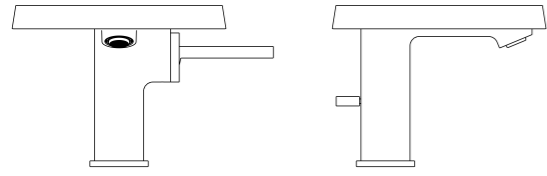

*/ column bath mixer /*



*/ basin mixer /*



*/ column basin mixer /*



*/ bidet mixer /*



*/ wall - mounted basin mixer /  
1-Point*



*/ bath mixer /  
1-Point*



*/ shower mixer /  
1-Point*



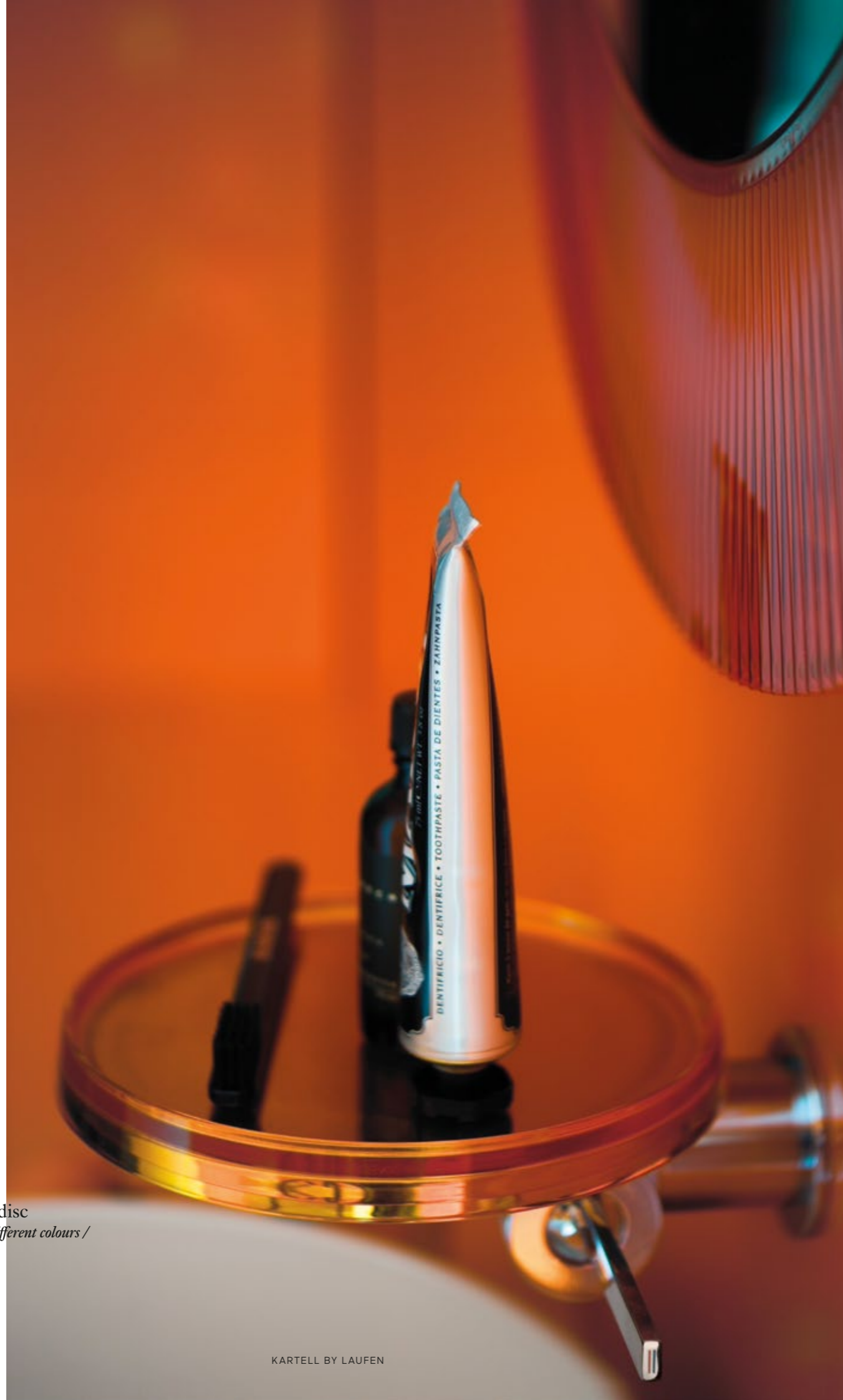

Removable disc  
*/ available in different colours /*





31133.1.004.111.1  
**Washbasin mixer, projection 110 mm, fixed spout, with pop-up waste\***  
 Waschtischmischer, Ausladung 110 mm, Festauslauf, mit Ablaufventil\*  
 Mitigeur de lavabo, saillie 110 mm, goulot fixe, avec vidage\*  
 Miscelatore per lavabo, sporgenza 110 mm, bocca d'erogazione fissa, con piletta\*

31133.1.004.113.1  
**Washbasin mixer, projection 110 mm, fixed spout, pop-up waste lever, without pop-up waste\***  
 Waschtischmischer, Ausladung 110 mm, mit Ablaufventilhebel, ohne Ablaufventil\*  
 Mitigeur de lavabo, saillie 110 mm, goulot fixe, avec commande de vidage, sans vidage\*  
 Miscelatore per lavabo, sporgenza 110 mm, bocca d'erogazione fissa, con leva di piletta, senza piletta\*

31133.1.004.110.1  
**Washbasin mixer, projection 110 mm, fixed spout, without pop-up waste\***  
 Waschtischmischer, Ausladung 110 mm, Festauslauf, ohne Ablaufventil\*  
 Mitigeur de lavabo, saillie 110 mm, goulot fixe, sans vidage\*  
 Miscelatore per lavabo, sporgenza 110 mm, bocca d'erogazione fissa, senza piletta\*

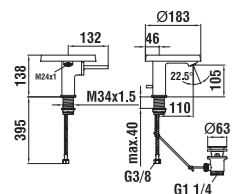

Colours: .004



31133.8.004.110.1  
**Column basin mixer, projection 110 mm, fixed spout, without pop-up waste\***  
 Standsäulen-Waschtischmischer, Ausladung 110 mm, Festauslauf, ohne Ablaufventil\*  
 Mitigeur de lavabo sur colonne, saillie 110 mm, goulot fixe, sans vidage\*  
 Miscelatore per lavabo a colonna alto, sporgenza 110 mm, bocca d'erogazione fissa, senza piletta\*

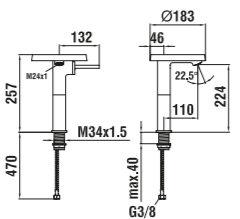

Colours: 004



34133.1.004.111.1  
**Bidet mixer, projection 125 mm, fixed spout, with pop-up waste\***  
 Bidetmischer, Ausladung 125 mm, Festauslauf, mit Ablaufventil\*  
 Mitigeur de bidet, saillie 125 mm, goulot fixe, avec vidage\*  
 Miscelatore per bidet, sporgenza 125 mm, bocca d'erogazione fissa, con piletta\*

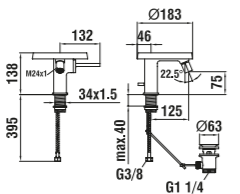

Colours: .004



32133.1.004.121.1  
**Column bath mixer complete with synthetic flexible hose 1250 mm and handspray twinstick, with Disc bowl transparent crystal (bowl available in 3 further colours)**  
 Standsäulen-Bademischer komplett, mit Kunststoffschlauch 1250 mm und Handbrause twinstick, mit Disc Ablageschale Kristallklar (Ablageschale in 3 weiteren Farben erhältlich)  
 Mitigeur de bain sur colonne complet avec flexible synthétique 1250 mm et douchette twinstick, avec Disc receveur transparent cristal (receveur disponible en 3 couleurs complémentaires)  
 Miscelatore da bagno a colonna completo, con tubo sintetico 1250 mm e doccetta twinstick, con Disc scodella trasparente cristallo (scodella disponibile in 3 colori ulteriori)

37098.5.000.000.1  
**Technical bloc for column bath mixer 32133.1.004.121.1**  
 Rohbaukörper zu Standsäulen-Bademischer 32133.1.004.121.1  
 Bloc technique pour mitigeur de bain sur colonne 32133.1.004.121.1  
 Blocco tecnico miscelatore da bagno a colonna 32133.1.004.121.1

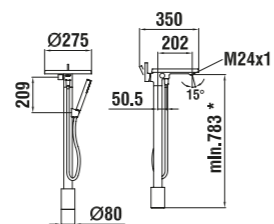

Colours: .004



31133.7.004.120.1  
**Wall-mounted washbasin mixer for Simibox 1-Point, projection 186 mm, fixed spout, with Disc bowl transparent crystal (bowl available in 3 further colours)**  
 Wand-Waschtischmischer für Simibox 1-Point, Ausladung 186 mm, Festauslauf, mit Disc Ablageschale Kristallklar (Ablageschale in 3 weiteren Farben erhältlich)  
 Mitigeur de lavabo mural pour Simibox 1-Point, saillie 186 mm, goulot fixe, avec Disc receveur transparent cristal (receveur disponible en 3 couleurs complémentaires)  
 Miscelatore di lavabo a parete per Simibox 1-Point, sporgenza 186 mm, bocca fissa, con Disc scodella trasparente cristallo (scodella disponibile in 3 colori ulteriori)

**Simibox 1-Point concealed box to be ordered separately**  
 Simibox 1-Point, Unterputz-Einbaukörper muss separat bestellt werden  
 Simibox 1-Point, corps encastré à commander séparément  
 Simibox 1-Point, corpo ad incasso da ordinare separatamente

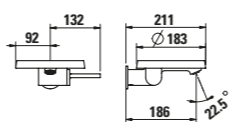

Colours: .004



32133.9.004.141.1  
**Bath mixer for Simibox 1-Point, with accessories, with Disc bowl transparent crystal (bowl available in 3 further colours)**  
 Bademischer für Simibox 1-Point, mit Zubehör, mit Disc Ablageschale Kristallklar (Ablageschale in 3 weiteren Farben erhältlich)  
 Mitigeur de bain pour Simibox 1-Point, avec accessoires, avec Disc receveur transparent cristal (receveur disponible en 3 couleurs complémentaires)  
 Miscelatore per bagno per Simibox 1-Point, con accessori, con Disc scodella trasparente cristallo (scodella disponibile in 3 colori ulteriori)

**Simibox 1-Point concealed box to be ordered separately**  
 Simibox 1-Point, Unterputz-Einbaukörper muss separat bestellt werden  
 Simibox 1-Point, corps encastré à commander séparément  
 Simibox 1-Point, corpo ad incasso da ordinare separatamente

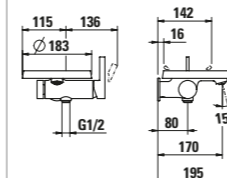

Colours: .004



33133.9.004.141.1  
**Shower mixer for Simibox 1-Point, with accessories, with Disc bowl transparent crystal (bowl available in 3 further colours)**  
 Duschenmischer für Simibox 1-Point, mit Zubehör, mit Disc Ablageschale Kristallklar (Ablageschale in 3 weiteren Farben erhältlich)  
 Mitigeur de douche pour Simibox 1-Point, avec accessoires, avec Disc receveur transparent cristal (receveur disponible en 3 couleurs complémentaires)  
 Miscelatore per doccia per Simibox 1-Point, con accessori, con Disc scodella trasparente cristallo (scodella disponibile in 3 colori ulteriori)

**Simibox 1-Point concealed box to be ordered separately**  
 Simibox 1-Point, Unterputz-Einbaukörper muss separat bestellt werden  
 Simibox 1-Point, corps encastré à commander séparément  
 Simibox 1-Point, corpo ad incasso da ordinare separatamente

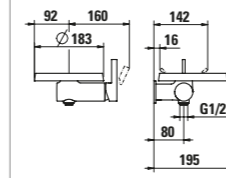

Colours: .004



37698.1.000.100.1  
**Simibox 1-Point, concealed box**  
 Simibox 1-Point, Unterputz-Einbaukörper  
 Simibox 1-Point, corps encastré  
 Simibox 1-Point, corpo ad incasso

3.7798.0.003.000.1  
**Simibox 1-Point mounting aid**  
 Simibox 1-Point Montagehilfe  
 Simibox 1-Point aide de montage  
 Simibox 1-Point set incasso per fissaggio a muro

3.7698.4.000.125.1  
**Simibox 1-Point extension 25 mm**  
 Simibox 1-Point Verlängerung 25 mm  
 Simibox 1-Point rallonge 25mm  
 Simibox 1-Point estensione da 25 mm

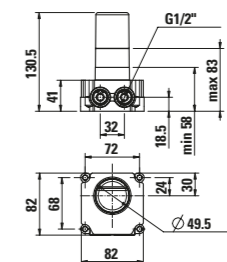

\* Incl. disc in colour transparent crystal (3 further colours available) - Inkl. Disc in der Farbe Kristallklar (3 weitere Farben erhältlich) - Incl. disc en couleur transparent cristal (disponible 3 couleurs complémentaires) - Incl. disc in colore trasparente cristallo (disponibile 3 colori ulteriori)



31133.1.xxx.101.1  
**Basin mixer, projection 115 mm, fixed spout, with pop-up waste**  
 Waschtischmischer, Ausladung 115 mm, Festauslauf, mit Ablaufventil  
 Mitigeur de lavabo, saillie 115 mm, goulot fixe, avec vidage  
 Miscelatore per lavabo, sporgenza 115 mm, bocca d'erogazione fissa, con piletta

31133.1.004.103.1  
**Basin mixer, projection 115 mm, fixed spout, with pop-up waste lever, without pop-up waste**  
 Waschtischmischer, Ausladung 115 mm, Festauslauf, mit Ablaufventilhebel, ohne Ablaufventil  
 Mitigeur de lavabo, saillie 115 mm, goulot fixe, avec commande de vidage, sans vidage  
 Miscelatore per lavabo, sporgenza 115 mm, bocca d'erogazione fissa, con leva di piletta, senza piletta

31133.1.xxx.100.1  
**Basin mixer, projection 115 mm, fixed spout, without pop-up waste**  
 Waschtischmischer, Ausladung 115 mm, Festauslauf, ohne Ablaufventil  
 Mitigeur de lavabo, saillie 115 mm, goulot fixe, sans vidage  
 Miscelatore per lavabo, sporgenza 115 mm, bocca d'erogazione fissa, senza piletta

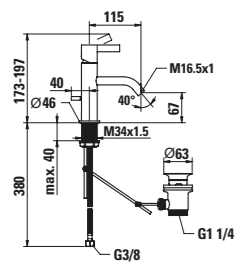

Colours: .004 .090 /.001 .092 .093



31133.1.xxx.121.1  
**Basin mixer, projection 135 mm, fixed spout, with pop-up waste**  
 Waschtischmischer, Ausladung 135 mm, Festauslauf, mit Ablaufventil  
 Mitigeur de lavabo, saillie 135 mm, goulot fixe, avec vidage  
 Miscelatore per lavabo, sporgenza 135 mm, bocca d'erogazione fissa, con piletta

31133.1.xxx.120.1  
**Basin mixer, projection 135 mm, fixed spout, without pop-up waste**  
 Waschtischmischer, Ausladung 135 mm, Festauslauf, ohne Ablaufventil  
 Mitigeur de lavabo, saillie 135 mm, goulot fixe, sans vidage  
 Miscelatore per lavabo, sporgenza 135 mm, bocca d'erogazione fissa, senza piletta

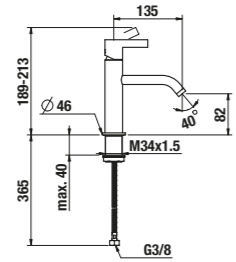

Colours: .004 .090 /.001 .092 .093



31133.8.xxx.120.1  
**Column basin mixer, projection 125 mm, fixed spout, without pop-up waste**  
 Standsäulen-Waschtischmischer, Ausladung 125 mm, Festauslauf, ohne Ablaufventil  
 Mitigeur de lavabo réhaussé, saillie 125 mm, goulot fixe, sans vidage  
 Miscelatore per lavabo a colonna, sporgenza 125 mm, bocca d'erogazione fissa, senza piletta

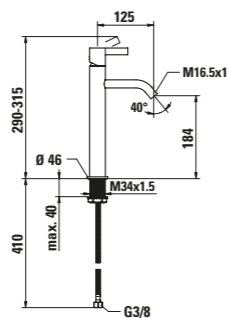

Colours: .004 .090 /.001 .092 .093



31133.2.004.221.1  
**2-hole basin mixer, projection 166 mm, swivel spout, with pop-up waste**  
 2-Loch Waschtischmischer, Ausladung 166 mm, Schwenkauslauf, mit Ablaufventil  
 Mélangeur de lavabo 2-trous, saillie 166 mm, goulot orientable, avec vidage  
 Miscelatore per lavabo con 2 fori, sporgenza 166 mm, bocca orientabile, con piletta

31133.2.004.223.1  
**2-hole basin mixer, projection 166 mm, swivel spout, with pop-up waste lever, without pop-up waste**  
 2-Loch Waschtischmischer, Ausladung 166 mm, Schwenkauslauf, mit Ablaufventilhebel, ohne Ablaufventil  
 Mélangeur de lavabo 2-trous, saillie 166 mm, goulot orientable, avec commande de vidage, sans vidage  
 Miscelatore per lavabo con 2 fori, sporgenza 166 mm, bocca d'erogazione fissa, con leva di piletta, senza piletta

31133.2.xxx.220.1  
**2-hole basin mixer, projection 166 mm, swivel spout, without pop-up waste**  
 2-Loch Waschtischmischer, Ausladung 166 mm, Schwenkauslauf, ohne Ablaufventil  
 Mélangeur de lavabo 2-trous, saillie 166 mm, goulot orientable, sans vidage  
 Miscelatore per lavabo con 2 fori, sporgenza 166 mm, bocca d'erogazione fissa, senza piletta

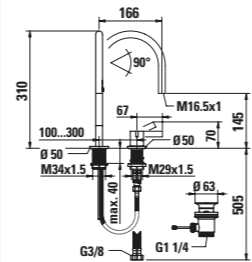

Colours: .004 .090



31233.3.004.221.1  
**Washbasin mixer 3-hole, swivel spout 166 mm, with pop-up waste**  
 Waschtischmischer 3-Loch, Schwenkauslauf Ausladung 166 mm, mit Ablaufventil  
 Mélangeur de lavabo 3-trous, goulot orientable saillie 166 mm, avec vidage  
 Miscelatore per lavabo a 3 fori, bocca orientabile sporgenza 166 mm, con piletta

31233.3.004.223.1  
**Washbasin mixer 3-hole, swivel spout, projection 166 mm, with pop-up waste lever, without pop-up waste**  
 Waschtischmischer 3-Loch, Schwenkauslauf, Ausladung 166 mm, mit Ablaufventilhebel, ohne Ablaufventil  
 Mélangeur de lavabo 3-trous, goulot orientable, saillie 166 mm, avec commande de vidage, sans vidage  
 Miscelatore per lavabo a 3 fori, bocca orientabile, sporgenza 166 mm, con leva di piletta, senza piletta

31233.3.004.220.1  
**Washbasin mixer 3-hole, swivel spout 166 mm, without pop-up waste**  
 Waschtischmischer 3-Loch, Schwenkauslauf Ausladung 166 mm, ohne Ablaufventil  
 Mélangeur de lavabo 3-trous, goulot orientable saillie 166 mm, sans vidage  
 Miscelatore per lavabo a 3 fori, bocca orientabile sporgenza 166 mm, senza piletta

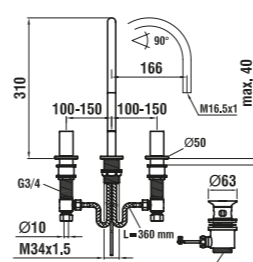

Colours: .004



31133.6.xxx.120.1  
**Wall-mounted mixer for Simibox 2-Point, projection 175 mm, fixed spout, without pop-up waste**  
 Wandmischer zu Simibox 2-Point, Ausladung 175 mm, Festauslauf, ohne Ablaufventil  
 Mitigeur mural pour Simibox 2-Point, saillie 175 mm, goulot fixe, sans vidage  
 Miscelatore a parete per Simibox 2-Point, sporgenza 175 mm, bocca d'erogazione fissa, senza piletta

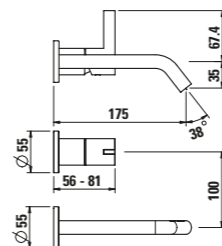

Colours: .004 .090 /.001 .092 .093



37698.1.000.251.1  
**Simibox 2-Point, concealed box**  
 Simibox 2-Point, UP-Einbaukörper  
 Simibox 2-Point, corps encastré  
 Simibox 2-Point, corpo ad incasso

3.7798.0.003.001.1  
 Simibox 2-Point mounting aid  
 Simibox 2-Point Montagehilfe  
 Simibox 2-Point aide de montage  
 Set incasso Simibox 2-Point

3.7998.4.000.225.1  
 Simibox 2-Point extension 25 mm  
 Simibox 2-Point Verlängerung 25 mm  
 Simibox 2-Point rallonge 25mm  
 Simibox 2-Point estensione da 25 mm

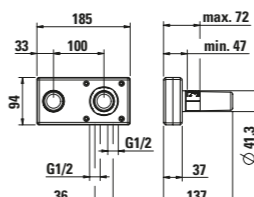

31233.6.004.120.1  
**Concealed washbasin wall mixer 2-handle, spout length 175 mm**  
 UP-Wandmischer 2-Griff, Ausladung 175 mm  
 Mélangeur de lavabo mural encastré 2 poignées, saillie 175 mm  
 Miscelatore da incasso a 2 manopole, sporgenza 175 mm

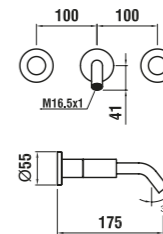

Colours: .004



37698.2.000.100.1  
**Brass rough-in concealed set for concealed 2 handles basin mixer**  
 31233.6.104.120.1  
 Messing Bausatz-Vormontage für 2-Griff UP-Waschtischmischer

31233.6.104.120.1  
 Set de pré-montage en laiton à encastrer pour mélangeur 2 poignées de lavabo mural encastré  
 31233.6.104.120.1  
 Set da incasso in ottone, per miscelatore da incasso a 2 manopole  
 31233.6.104.120.1

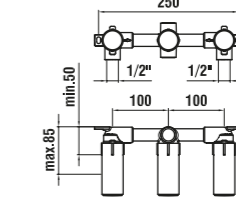

34133.1.xxx.101.1  
**Bidet mixer, projection 110 mm, fixed spout, with pop-up waste**  
 Bidetmischer, Ausladung 110 mm, Festauslauf, mit Ablaufventil  
 Mitigeur de bidet, saillie 110 mm, goulot fixe, avec vidage  
 Miscelatore per bidet, sporgenza 110 mm, bocca d'erogazione fissa, con piletta

34133.1.xxx.103.1  
**Bidet mixer, projection 110 mm, fixed spout, with pop-up waste lever, without pop-up waste**  
 Bidetmischer, Ausladung 110 mm, Festauslauf, mit Ablaufventilhebel, ohne Ablaufventil  
 Mitigeur de bidet, saillie 110 mm, goulot fixe, avec commande de vidage, sans vidage  
 Miscelatore per bidet, sporgenza 110 mm, bocca d'erogazione fissa, con leva di piletta, senza piletta

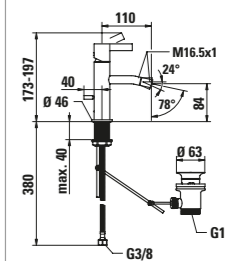

Colours: .004 .090 /.001 .092 .093



33133.7.004.141.1  
**Shower mixer 150 mm, complete with synthetic flexible hose 1800 mm and twinstick handspray**  
 Duschenmischer 150 mm, komplett mit Kunststoffschlauch 1800 mm und twinstick Handbrause  
 Mitigeur de douche 150 mm, complet avec flexible synthétique 1800 mm et douchette twinstick  
 Miscelatore da doccia 150 mm, completo con tubo sintetico 1800 mm e doccetta twinstick

33133.7.004.400.1  
**Shower mixer 150 mm, with fittings, without accessories**  
 Duschenmischer 150 mm, mit Verschraubungen, ohne Zubehör  
 Mitigeur de douche 150 mm, avec raccords, sans accessoires  
 Miscelatore da doccia 150 mm, con raccordi, senza accessori

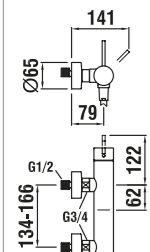

Colours: .004



33133.6.xxx.000.1  
**Set for concealed shower mixer Simibox**  
 Fertigmontage-Set für UP-Duschenmischer Simibox  
 Habillage extérieur pour mitigeur de douche encastré Simibox  
 Set di montaggio per miscelatore da doccia ad incasso Simibox

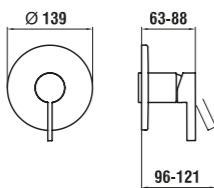

Colours: .004 .090 /.001 .092 .093



32133.6.xxx.000.1  
**Set for concealed bath/shower mixer Simibox, with diverter**  
 Fertigmontage-Set für UP-Bademischer Simibox, mit Umsteller  
 Habillage extérieur pour mitigeur de bain/douche encastré Simibox, avec inverseur  
 Set di montaggio per miscelatore da bagno ad incasso Simibox, con deviatore

32133.6.xxx.010.1  
**Set for concealed bath/shower mixer Simibox, with diverter and vacuum breaker**  
 Fertigmontage-Set für UP-Bademischer Simibox, mit Umsteller und Sicherheitseinrichtung  
 Décor de mitigeur bain/douche Simibox, avec inverseur et avec anti-siphonnage  
 Set di montaggio per miscelatore da bagno ad incasso Simibox, con deviatore e dispositivo di sicurezza

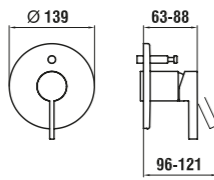

Colours: .004 .090 /.001 .092 .093



32233.5.004.282.1  
**Roman tub filler 5-holes, spout 173 mm, without plate**  
 Wannenfüllkombination 5-Loch, Ausladung 173 mm, ohne Platte  
 Garniture de remplissage de baignoire 5 trous, goulot 173 mm, sans plaque  
 Bordo vasca 5 fori, sporgenza 173 mm, senza piastra

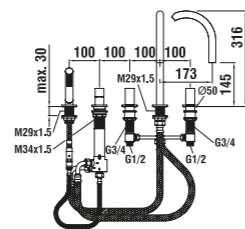

Colours: .004



37133.0.xxx.060.1  
**Wall mounted fixed spout 175 mm**  
 Wanneneinlauf, Ausladung 175 mm  
 Goulot mural, saillie 175 mm  
 Bocca di erogazione vasca, sporgenza 175 mm

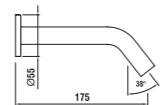

Colours: .004 .090 /.001 .092 .093

37898.0.000.000.1  
**Simibox Standard, concealed system for bath and shower mixer**  
 Simibox Standard, Unterputz-Einbaukörper für Bade- und Duschenmischer  
 Simibox Standard, corps encastré pour mitigeur de bain et de douche  
 Simibox Standard, corpo da incasso per miscelatore da bagno e doccia

37898.0.000.101.1  
**Simibox Light, concealed system for bath and shower mixer**  
 Simibox Light, Unterputz-Einbaukörper für Bade- und Duschenmischer  
 Simibox Light, corps encastré pour mitigeur de bain et de douche  
 Simibox Light, corpo da incasso per miscelatore da bagno e doccia

37898.0.000.100.1  
**See above, with stop valves**  
 Wie oben, mit Vorabsperrung  
 Voir ci-dessus, avec arrêt des eaux  
 Vedi sopra, con chiusura acqua

37998.0.003.000.1  
**Simibox Standard & Light, mounting aid, in/outside wall, fixing material**  
 Simibox Standard & Light, Montagehilfe in/vor die Wand, Befestigungsmaterial  
 Simibox Standard & Light, aide de montage, dans/devant le mur, matériel de fixation  
 Simibox Standard & Light, set di montaggio, in/a parete, materiale di fissaggio

37998.0.000.500.1  
**Simibox Standard & Light, mounting flanges for Simibox**  
 Simibox Standard & Light, Flansche zu Simibox  
 Simibox Standard & Light, brides pour Simibox  
 Simibox Standard & Light, flangia per Simibox

37998.0.000.050.1  
**Extension set 25 mm, for Simibox**  
 Verlängerungsset 25 mm, für Simibox  
 Jeu de rallonge 25 mm, pour Simibox  
 Set di prolunga 25 mm, per Simibox

37998.0.000.060.1  
**Extension set 50 mm, for Simibox**  
 Verlängerungsset 50 mm, für Simibox  
 Jeu de rallonge 50 mm, pour Simibox  
 Set di prolunga 50 mm, per Simibox

37998.4.xxx.050.1  
**Extension ring for rose, 15 mm**  
 Verlängerungsring zu Rosette, 15 mm  
 Bague de rallonge pour rosace, 15 mm  
 Anello di prolunga per rosetta, 15 mm

37998.4.xxx.060.1  
**Extension ring for rose, 30 mm**  
 Verlängerungsring zu Rosette, 30 mm  
 Bague de rallonge pour rosace, 30 mm  
 Anello di prolunga per rosetta, 30 mm

Colours: .004 .090



32362.6.004.200.1  
**Twintherm set for concealed thermostatic 2-handle bath mixer, for Simibox Light & Standard, with 2 outlets for mixed water, safety button, manual diverter, thermostatic cartridge, chrome**  
 Twintherm Fertigmontage-Set für thermostatischen 2-Griff Unterputz-Bademischer, zu Simibox Light & Standard, mit 2 Mischwasserabgängen, Sicherheitstaste, manueller Umsteller, thermostatische Patrone, Chrom  
 Twintherm habillage extérieur pour mitigeur de bain 2-poignées thermostatique encastré, pour Simibox Light & Standard, avec 2 sorties d'eau mélangée, touche de sécurité, inverseur manuel, cartouche thermostatique, chromé  
 Twintherm set miscelatore termostatico da bagno a incasso 2 manopole, per Simibox Light & Standard, con 2 uscite d'acqua miscelata, tasto di sicurezza, commutazione manuale, cartuccia termostatica, cromato

32362.6.004.210.1  
**See above, with integrated vacuum breaker**  
 Wie oben, mit integriertem Rohrunterbrecher  
 Voir ci-dessus, avec anti-siphonage  
 Vedi sopra, con disconnettore integrato

33362.6.004.200.1  
**Twintherm set for concealed thermostatic 2-handle shower mixer, for Simibox Light & Standard, safety button, thermostatic cartridge, chromed**  
 Twintherm Fertigmontage-Set für thermostatischen 2-Griff Unterputz-Duschenmischer, zu Simibox Light & Standard, Sicherheitstaste, thermostatische Patrone, Chrom  
 Twintherm habillage extérieur pour mitigeur de douche 2-poignées thermostatique encastré, pour Simibox Light & Standard, touche de sécurité, cartouche thermostatique, chromé  
 Twintherm set miscelatore termostatico da doccia a incasso 2 manopole, per Simibox Light & Standard, tasto di sicurezza, cartuccia termostatica, cromato

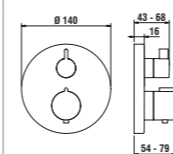

Colours: .004



36798.1.004.210.1  
**Shower head round Ø 206 mm**  
 Regenbrause rund Ø 206 mm  
 Pommeau de douche rond Ø 206 mm  
 Soffione doccia circolare Ø 206 mm

36798.1.004.220.1  
**Shower head round Ø 247 mm**  
 Regenbrause rund Ø 247 mm  
 Pommeau de douche rond Ø 247 mm  
 Soffione doccia circolare Ø 247 mm

36798.1.004.230.1  
**Shower head round Ø 306 mm**  
 Regenbrause rund Ø 306 mm  
 Pommeau de douche rond Ø 306 mm  
 Soffione doccia circolare Ø 306 mm

36798.1.004.240.1  
**Shower head round Ø 356 mm**  
 Regenbrause rund Ø 356 mm  
 Pommeau de douche rond Ø 356 mm  
 Soffione doccia circolare Ø 356 mm

**Wall or ceiling arm must be ordered separately**  
 Wand- oder Deckenarm separat bestellbar  
 Bras mural ou plafonnier à commander séparément  
 Braccio da parete o da soffitto, da ordinare separatamente

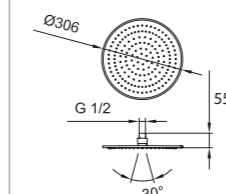

Colours: .004



36798.1.004.410.1  
**Shower head oval 226x346 mm**  
 Regenbrause oval 226x346 mm  
 Pommeau de douche ovale 226x346 mm  
 Soffione doccia ovale 226x346 mm

**Wall or ceiling arm must be ordered separately**  
 Wand- oder Deckenarm separat bestellbar  
 Bras mural ou plafonnier à commander séparément  
 Braccio da parete o da soffitto, da ordinare separatamente

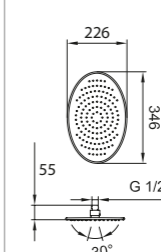

Colours: .004



36798.1.003.231.1  
**Round rain showerhead ultra thin, Ø 300 mm, brushed stainless steel**  
 Runde Regenbrause ultraflach, Ø 300 mm, Edelstahl gebürstet  
 Pomme de douche ronde ultra mince, Ø 300 mm, acier inox brossé  
 Soffione doccia circolare ultrasottile, Ø 300 mm, acciaio inox spazzolato

**Wall or ceiling arm must be ordered separately**  
 Wand- oder Deckenarm separat bestellbar  
 Bras mural ou plafonnier à commander séparément  
 Braccio da parete o da soffitto, da ordinare separatamente

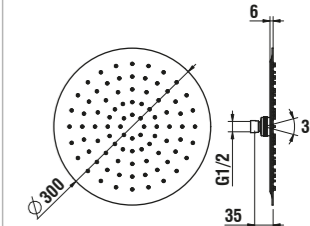



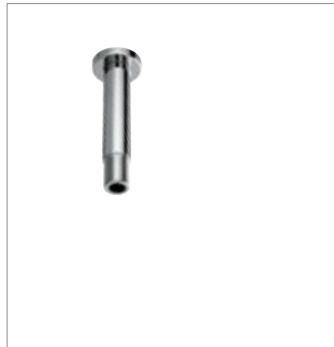

36698.0.xxx.002.1  
**Shower ceiling arm with round rosette, 100 mm, suitable for oval and round shower heads**  
 Brausendeckenarm mit runder Rosette, 100 mm, passend zu Regenbrausen oval und rund  
 Bras de douche plafonnier avec rosace ronde, 100 mm, convient aux pommeaux de douche ovales et ronds  
 Braccio doccia a soffitto con rosetta circolare, 100 mm, adatto a soffione doccia ovale e circolare

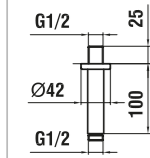

Colours: .004 .090

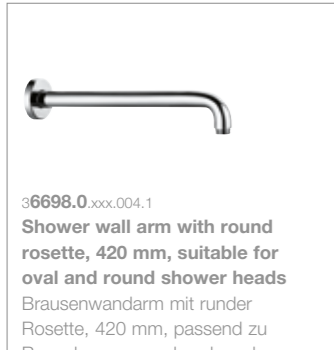

36698.0.xxx.004.1  
**Shower wall arm with round rosette, 420 mm, suitable for oval and round shower heads**  
 Brausenwandarm mit runder Rosette, 420 mm, passend zu Regenbrausen oval und rund  
 Bras de douche mural avec rosace ronde, 420 mm, convient aux pommeaux de douche ovales et ronds  
 Braccio doccia a parete con rosetta circolare, 420 mm, adatto a soffione doccia ovale e circolare

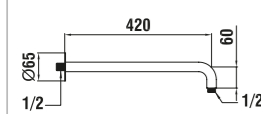

Colours: .004 .090



36498.0.xxx.310.1  
**Shower slide bar, 600 mm**  
 Duschgleitstange, 600 mm  
 Glissière de douche, 600 mm  
 Alta salicendi per doccia, 600 mm

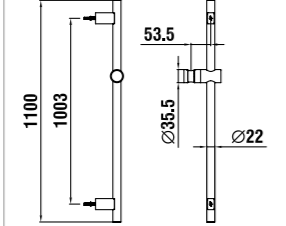

Colours: .004 .090



36398.0.xxx.152.1  
**Wall connection elbow with fixed handspray holder**  
 Anschlussbogen mit Handbrausenhalter  
 Coude mural avec support fixe pour douchette  
 Gomito al muro con supporto fisso per doccetta

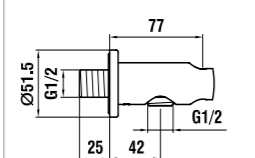

Colours: .004 .090



36998.0.xxx.201.1  
**Wall connection elbow**  
 Fester Halter  
 Support fixe  
 Supporto fisso

Colours: .004 .090



36298.0.090.140.1  
**Synthetic flexible hose 1/2"x 1/2", 180 cm**  
 Kunststoffschlauch 1/2"x 1/2", 180 cm  
 Flexible synthétique, 1/2"x 1/2", 180 cm  
 Flessibile sintetico, 1/2"x 1/2", 180 cm

Colours: .090



36198.2.xxx.125.1  
**Hand shower TwinStick, 1 spray**  
 Handbrause TwinStick, 1 Brausestrahl  
 Douchette à main TwinStick, 1 jet  
 Doccetta TwinStick, 1 spray

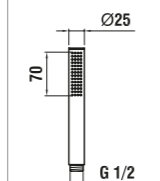

Colours: .004 .090

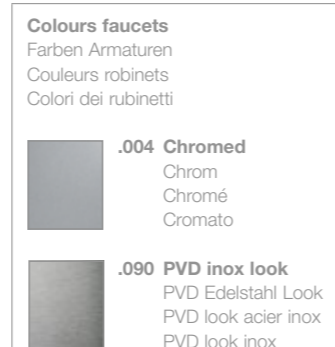

**Colours faucets**  
 Farben Armaturen  
 Couleurs robinets  
 Colori dei rubinetti

**Special colours available from 100 pcs.**  
 Sonderfarben verfügbar ab 100 Stk.  
 Couleurs spéciales disponibles à partir de 100 pc.  
 Colori speciali disponibili da 100 pz.

- .004 Chromed**  
 Chrom  
 Chromé  
 Cromato
- .090 PVD inox look**  
 PVD Edelstahl Look  
 PVD look acier inox  
 PVD look inox
- .001 PVD gold**  
 PVD Gold  
 PVD or  
 PVD oro
- .092 PVD brushed anthracite**  
 PVD Anthrazit gebürstet  
 PVD anthracite brossé  
 PVD antracite spazzolato
- .093 PVD copper**  
 PVD Kupfer  
 PVD cuivre  
 PVD rame



**Colours discs**  
 Farben Discs  
 Couleurs discs  
 Colori discs

- .081 Amber**  
 Bernstein  
 Ambre  
 Ambra
- .082 Tangerine orange**  
 Mandarine  
 Orange tangerine  
 Arancio tangerine
- .084 Transparent crystal**  
 Kristallklar  
 Transparent cristal  
 Trasparente cristallo
- .085 Smoky grey**  
 Rauchgrau  
 Fumé  
 Fumé

The illustrated colours only approximately correspond to the actual shades. The bathroom layouts shown here are purely decorative and do not reflect all the technical requirements. The decorative parts used are not included in our commercial offer.

Die Farbabbildungen entsprechen nur in etwa den tatsächlichen Farbtönen. Die hier gezeigten Badmilleus sind rein dekorativ und berücksichtigen nicht alle technischen Anforderungen. Unser Angebot beinhaltet nicht die verwendete Dekoration.

Les photos couleur ne correspondent que partiellement aux teintes effectives. Les ambiances reproduites ici sont simplement décoratives, les exigences techniques d'installation n'ont pas toujours été prises en compte. La décoration utilisée ne fait pas partie de notre offre commerciale.

I colori qui illustrati non corrispondono esattamente alle tonalità effettive. Gli ambienti qui riprodotti sono puramente decorativi e non tengono conto di tutte le specifiche tecniche. Gli articoli d'arredo usati non fanno parte della nostra offerta commerciale.

It is possible that not all products, sizes or colours are available in every country. The price list of your LAUFEN subsidiary is the most accurate reference point for product availability. Delivery periods may also differ.

Unter Umständen sind nicht alle Produkte, Größen oder Farben in jedem Land verfügbar. Bitte nutzen Sie die Preisliste der jeweiligen LAUFEN Niederlassung als Referenz für das verfügbare Produktsortiment. Auch die jeweiligen Lieferzeiten können von Land zu Land abweichen.

Il se peut que les produits ne soient pas tous disponibles dans chaque pays dans toutes les dimensions et coloris. La liste de prix de votre filiale LAUFEN est la référence la plus sûre en ce qui concerne la disponibilité des produits. Les délais de livraisons peuvent également varier d'un pays à l'autre.

È possibile che non tutti i prodotti, le misure e i colori siano ugualmente disponibili in ogni Paese. Si prega di utilizzare il listino prezzi della vostra filiale LAUFEN come riferimento per la gamma di prodotti disponibili. Anche i tempi di consegna possono variare da un Paese all'altro.

Printed on certified paper from sustainably managed forests.  
 Gedruckt auf zertifiziertem Papier. Aus nachhaltig bewirtschafteten Wäldern.  
 Imprimé sur du papier certifié. Issu de forêts exploitées de façon durable.  
 Stampato su carta certificata. Proveniente da boschi a gestione sostenibile.

We reserve the right to make technical changes without prior notice. Registered design.

Technische Änderungen sind vorbehalten. Design geschützt.

Sous réserve de modifications techniques. Modèle déposé.

Con riserva di apportare modifiche tecniche. Modello depositato.

**Headquarters:**

LAUFEN Bathrooms AG  
Wahlenstrasse 46  
CH-4242 Laufen  
Tel. +41 61 765 71 11  
feedback@laufen.ch  
www.laufen.com

**Export:**

LAUFEN Bathrooms AG  
Wahlenstrasse 46  
CH-4242 Laufen  
Tel. +41 61 765 76 09  
export@laufen.ch  
www.laufen.com/export

**Asia:**

Roca Sanitaryware Ltd.  
Room 2303, 23/F  
148 Electric Road  
North Point, Hong Kong  
Tel. +852 250 624 38  
Fax +852 250 624 92  
laufenasia@hongkong.laufen.ch  
www.laufen.com/export

**Oceania:**

**Australia, New Zealand & other**  
Roca Bathroom Products  
Australia P/L  
Level 10, Suite 1004  
46 Market Street  
Sydney NSW 2000  
Australia  
Tel. +61 (2) 9290 2331  
aus.admin@roca.net  
www.laufen.com.au

**Austria:**

LAUFEN Austria AG  
Mariazeller Strasse 100  
A-3150 Wilhelmsburg  
Tel. +43 2746 6060  
Fax +43 2746 6060 380  
office.wi@at.laufen.com  
www.laufen.co.at

**Bosnia and Herzegovina,  
Croatia, Kosovo, Macedonia,  
Montenegro, Serbia, Slovenia:**

INKER d.d.  
Industrijska 1  
10290 Zaprešić  
Tel. +385 1 3310 364  
Fax +385 1 3310 275  
komercijala@inkerc.hr  
www.laufen.hr

**Benelux:**

LAUFEN Benelux B.V.  
Meidoornkade 2A  
NL-3992 AE Houten  
Tel. +31 (0)33 450 20 90  
info.benelux@laufen.ch  
www.laufen.nl  
www.laufen.be

**Brazil:**

Roca Sanitários Brasil Ltda.  
Av. 14 de Dezembro,  
2.800 - V. Mafalda  
CEP: 13206-105  
Jundiaí - SP - Brasil  
PABX: +55 11 3378 4600  
Assistência Técnica:0800 70 11 510  
info.br@laufen.com  
www.laufen.com.br

**Bulgaria:**

Roca Bulgaria AD  
5, Pirotska Str.  
1301 Sofia, Bulgaria  
Tel. +359 2 930 59 10  
Fax +359 2 930 59 18  
office.sofia@bg.roca.net  
www.bg.roca.com

**China:**

Roca Sanitary Trading  
(Shanghai) co. Ltd  
Room 503-505, City Gateway  
No. 396 North Caoxi Road  
Shanghai 200030, China  
Tel. +86 21 3368 8822  
Fax +86 21 3368 8299  
laufen\_cn@roca.net.cn  
www.cn.laufen.com

**Czech Republic:**

LAUFEN CZ s.r.o.  
V Tůních 3/1637  
120 00 Praha 2  
Tel. +420 296 337 701  
prague.gallery@cz.laufen.com  
www.laufen.cz

**Estonia, Latvia:**

LAUFEN CZ s.r.o.  
Pae 25-8  
Tallinn, 11414  
Estonia  
Tel. +372 6 215 569  
office.tallinn@ee.laufen.com  
www.laufen.ee  
www.laufen.lv

**France:**

Roca S.A.R.L.  
Marque LAUFEN  
Immeuble le Rond Point  
5 Boulevard de l'Oise  
F-95015 Cergy Pontoise Cédex  
Tel. +33 1 34 40 39 31  
Fax +33 1 30 37 02 65  
commercial@roca.fr  
www.laufen.fr

**Germany:**

Roca GmbH  
Vertrieb LAUFEN  
Fincheswiese 17  
56424 Staudt  
Germany  
Tel. +49 26 02 / 94 93 33  
Fax +49 26 02 / 94 93 355  
info.staudt@de.laufen.com  
www.de.laufen.com

**Hungary:**

LAUFEN CZ s.r.o.  
Hungarian Trade Agency  
Pasaréti u. 83  
H-1026 Budapest  
Tel. +36 1 274 05 35  
Fax +36 1 391 04 58  
office.budapest@hu.laufen.com  
www.laufen.hu

**India:**

Roca Bathroom Products Pvt. Ltd.  
3rd Floor, Tower B,  
DLF Building No. 10, Phase – II  
DLF Cyber City,  
Gurgaon – 122002, Haryana  
India  
Tel. +91 124 4278347-49  
Fax +91 124 4278350  
Info.laufen@in.roca.com  
www.laufen.in

**Italy:**

LAUFEN CZ s.r.o.  
V Tůních 3/1637  
CZ-120 00 Praha 2  
Tel. +39 02 90016001  
Fax. +39 02 90016011  
www.laufen.it

**Lithuania:**

LAUFEN CZ s.r.o.  
Užupio g. 30  
Vilnius, 01203  
Lietuva  
Tel. +370 5 215 30 76  
office.vilnius@lt.laufen.com  
www.laufen.it

**Morocco:**

Roca Maroc, S.A.  
route de Marrakech, km 2,5  
BP 571, 26000 Settat  
Tel. +212 5 23 40 59 41  
Fax +212 5 23 40 59 42  
www.roca.com

**Nordic Countries:**

**Denmark, Finland, Greenland, Iceland**  
LAUFEN Nordic Aps  
Tømmervej 2  
4600 Køge  
Denmark  
Tel. +45 56 287 287  
info@dk.laufen.com  
www.laufen.dk  
www.laufen.fi

**North America:**

LAUFEN Bathrooms North America  
Showroom  
7610 NE 4th Court, Suite 104  
Miami, FL 33138  
USA  
Toll free phone +1 (866) 696-2493  
+1 (305) 357-6130  
Toll free fax +1 (866) 628-1760  
usa@laufen.com  
canada@laufen.com  
www.laufen.com/usa  
www.laufen.com/ca  
www.laufen.com.mx

**Norway:**

Laufen Norge AS  
Syretårnet 41  
NO-3048 Drammen  
Tel.: +47 32 27 60 70  
firmapost@no.laufen.com  
www.laufen.no

**Poland:**

Roca Polska Sp. z o.o.  
ul. Wyczółkowskiego 20  
44-109 Gliwice  
Tel. +48 32 339 41 00  
biuro@roca.pl  
www.laufen.pl

**Portugal:**

Roca, S.A., Portugal  
Apartado 575, Ponte da Madalena  
2416-905 - Leiria, Portugal  
Tel. +351 244 720 000  
marketing.le@pt.roca.net  
www.laufen.pt

**Romania:**

Roca Obiecte Sanitare S.R.L.  
Blvd. Preciziei nr. 1, Sector 6  
062202 - Bucharest - Romania  
Tel. +4031 822 2310  
Fax +4021 318 1418  
www.ro.roca.com

**Russia:**

Roca Rus  
Promyshlennaya Str. 7, Tosno  
Leningrad region, 187000, Russia  
Tel. +7 812 347 94 49  
marketing@ru.roca.com  
www.laufen.ru

**Roca Rus**

2nd Khutorskaya, 38A, building 14  
Moscow, 127287, Russia  
Tel. +7 495 989 65 91  
marketing@ru.roca.com  
www.laufen.ru

**Slovakia:**

LAUFEN SK s.r.o.  
Štefanovičova 12,  
811 04 Bratislava  
Tel. +421 2 52 621 024  
www.sk.laufen.com

**Spain:**

Laufen Bathrooms S.A.  
C/Covarrubias 23  
28010 Madrid  
Spain  
Phone: +34 900 103 258  
info@es.laufen.com  
www.laufen.es

**Sweden:**

Laufen Sverige AB  
Kämpegatan 15  
SE-41104 Göteborg  
Tel. +46 (0) 823 44 44  
info@se.laufen.com  
www.laufen.se

**Switzerland:**

Keramik Laufen AG  
Wahlenstrasse 46  
CH-4242 Laufen  
Tel. +41 61 765 71 11  
forum@laufen.ch  
www.laufen.ch

**Ukraine:**

LAUFEN CZ s.r.o. Ukraine  
Kiev 04128  
19, Ak. Tupoleva str., office „Laufen“  
Tel. +380 44 499 0620  
Fax +380 44 499 0621  
office.kiev@ua.laufen.com  
www.ua.laufen.com

**United Kingdom and Ireland:**

ROCA Limited  
c/o Laufen Limited  
Hermitage Industrial Estate  
Samson Road  
Coalville  
LE67 3FP  
Tel. +44 (0)1530 510007  
info@uk.laufen.com  
www.uk.laufen.com

**Art direction:**

PS+A

**Photo:**

ADRIANO BRUSAFERRI  
MAX ZAMBELLI  
ROBERTO PALOMBA

**Thanks to:**

BRIX – IL CASONE – COTÉ BASTIDE – DE VECCHI MILANO 1935  
DRESSWALL – GIGACER – G.T. DESIGN – IVANO REDAELLI – JOE MALONE  
KENZOKI – KERAKOLL DESIGN HOUSE – KOHRO – LUDOVICO MARTELLI SRL  
MISHA WALLPAPER – MARIANNAUD PARFUMERIES ITALIA – MARTINI SPA  
NARCISO RODRIGUEZ – PROFUMUM ROMA – SOCIETY – TEIXIDORS

